



NAVONA

1

# Company History and Mission



# Company

**Navona, offers a wide range of “Made in Italy” kitchens, baths, interior doors and closet systems.**

Operating in the US multi-family, residential market for over a decade with 10,000+ kitchens & baths furnished to development projects and clients large and small.

Offering an extensive range of materials, finishes, colors and hardware to enhance any design aesthetic.

Our design team can recommend customized options to align with a client’s vision & budget.



# Why Navona?



Project  
Management



Made  
in Italy



Product  
Quality



Sustainability



# Project Management & Sales Support

- Project Assessment
- Kick-Off Charette
- Project Plan
- Samples
- Design
- VE Support
- Shop Drawings
- Logistics
- Installer Training
- Post-Sale Service
- Real-Time Container Tracking Software
- Maintenance & Care

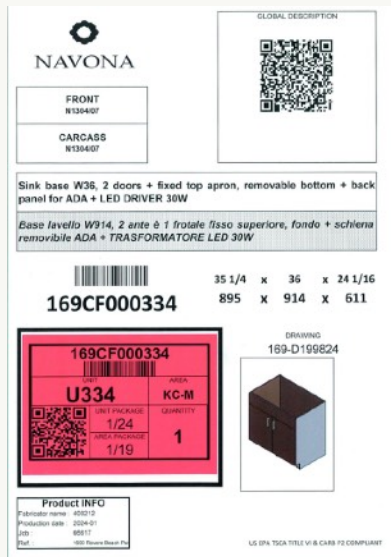

Unique QR Code Labeling

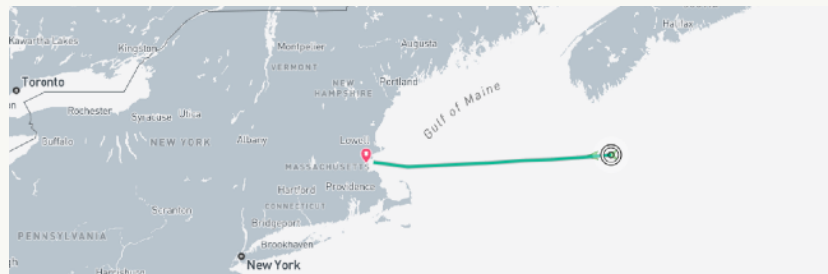
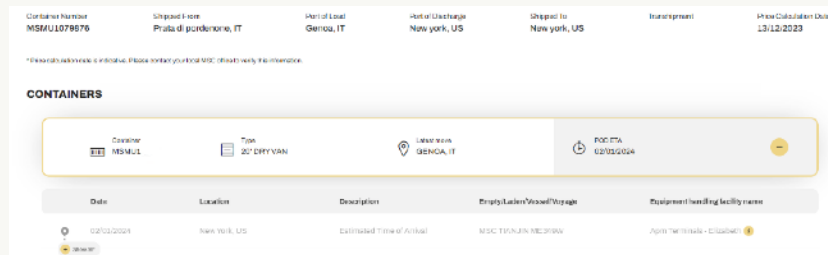

Real-Time Container Tracking Software

# High Quality Products

- Wood and wood-derived raw materials are procured from the highest quality sources
- Our product is rigorously tested for durability and performance
- High quality hardware, customizable inserts and accessories
- Improve the kitchen experience by designing well-organized, functional spaces
- Casework designed to meet the requirements and measurements set out by the American Disabilities Act (ADA)



# Made in Italy

Manufacturing facilities located in the Italian “**Kitchen District**”, a geographical area in the Northeast with:

- Several decades of industrial **strategic know-how**.
- Main hub for **design** and **product innovation** in our industry, with **direct** access to materials before they are available in the market.

## Manufacturing Facilities

- U2. Lacquering Department
- U3. Finish Product Warehouse
- U4. Door Assembling & Packaging
- U5. Postforming & Packaging
- U6. Assembly and Packaging
- U7. R&D Lab. - Showroom
- U8. Distribution Centre
- U9. Raw Materials Warehouse
- U11. Pick and Pack
- U12. Assembly and Packaging

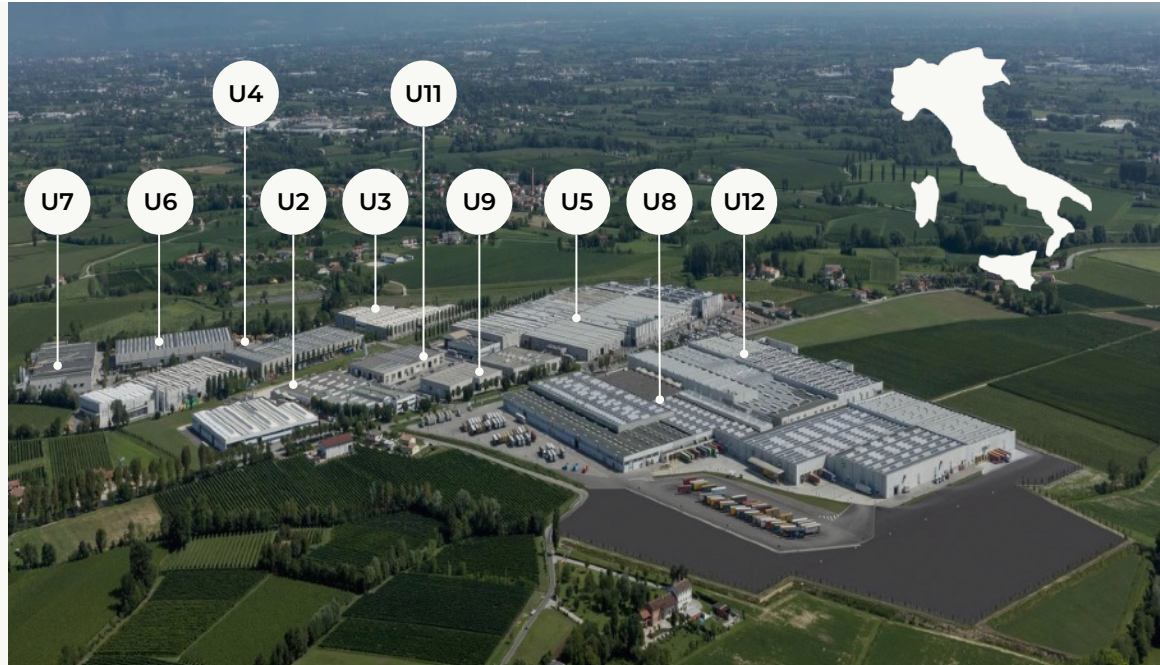

# Sustainability

- Certified, high-quality material sourcing
- Sustainable manufacturing process
- Certified sustainable products and finishes
- Responsible forested wood materials
- Formaldehyde free cabinetry
- VOC-free painted surfaces



# 2

## Kitchen & Bath Offerings



# Panel Materials



## Particle Board Substrate (P2) Finish Options:

**Group 1:** Slab wood grain melamine door with wood grain ABS edge,  $\frac{3}{4}$ "

**Group 1a:** Slab wood grain melamine door with wood grain ABS edge,  $\frac{7}{8}$ "

**Group 2:** Fully integrates pull melamine door with wood grain ABS edge,  $\frac{7}{8}$ "

**Group 3:** Slab white glossy UV-lacquered door,  $\frac{3}{4}$ "

**Group 5:** Slab wood veneer door, matte finishing,  $\frac{3}{4}$ "

**Group 5a:** Slab wood veneer door, matte finishing,  $\frac{7}{8}$ "

## MDF Substrate Group Finish Options:

**Group 4:** Recessed panel door, wrapped with thermofoil,  $\frac{7}{8}$ "

**Group 6:** Slab white glossy lacquered door,  $\frac{3}{4}$ "

**Group 6a:** Slab white glossy lacquered door,  $\frac{7}{8}$ "

**Group 7:** Full integrate J-pull white glossy lacquered door,  $\frac{7}{8}$ "  
Glossy finish on front and back surfaces and edges

**Group 8:** Recessed panel door, matt lacquered,  $\frac{7}{8}$ ". 6 surface, 5-piece design

# Group Finishes

## Standard Group 1 Finishes

Navona offers over 80 options for Group 1 finishes in MFC laminates. Group 1 finishes offer several advantages, including discounted pricing and more readily available materials that decrease lead time.

### Finishes included in the Group 1 offering:

- Solid colours
- Mixed finishes (ie. linen textures, resins and concrete looks)
- Wood finishes

## Solid Colours

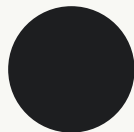

308 Nero-  
N1306/07



368 Grigio-  
N1332/07



AP2 Grigio-  
N1327/07



AS1 Grigio-  
N1325/07

## Mixed Materials



Arduo Front  
N1574/11



Argilla Front  
N104/02



Bronzo Front  
N1503/02



Canebola Front  
N136/02

## Wood

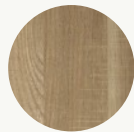

Rovere Bruges  
N166/08



Rovere Metz  
N452/08

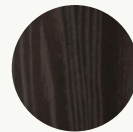

Rovere Moresco  
N1462/04



Rovere Rock Bianco  
N464/08



# Opening Systems

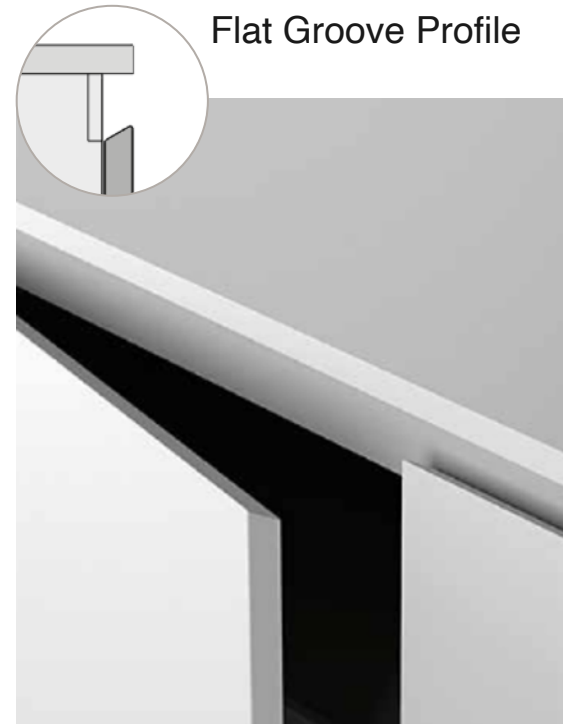

# Hardware

## Soft-Close Hinges



## Clip-On Finished Toe Kick

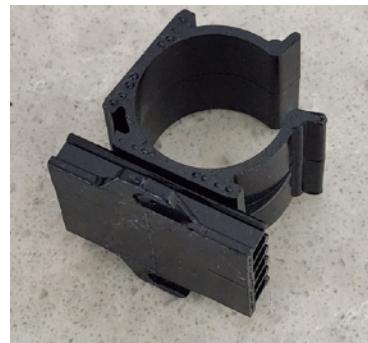

## Soft-Close Drawer Systems



# Under-Cabinet Lighting

## Under-Cabinet Integrated Lights



# Customizable Inserts & Accessories

Efficiency Corners

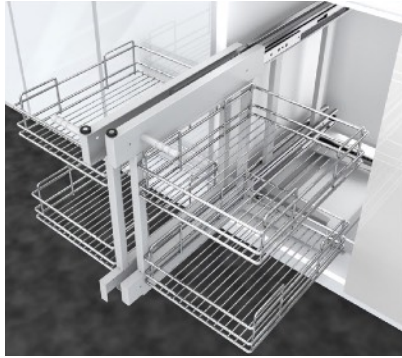

Trash Bins



Integrated Power Outlet & Charging Station



Pull-Out Shelves & Bread Boards



# 3

## Closet Offerings



# Closet System

The flexibility of the closet's modular design enables an easy-to-manage installation process.



3

Interior  
Door  
Offerings



# Interior Doors

Our Interior doors with assembly profiles reduce installation time. REI fire doors include different opening solutions: hinged, sliding, book or wall flush, as well as a wide variety of sizes and uses.



4

# Amenities Offerings



# Amenities

## Hotel / Restaurant

We provide complete and customized furniture for all environments, from upholstered furniture to accessories and lighting for: guest rooms, common areas, lobbies, reception areas, meeting rooms, restaurants and spas.

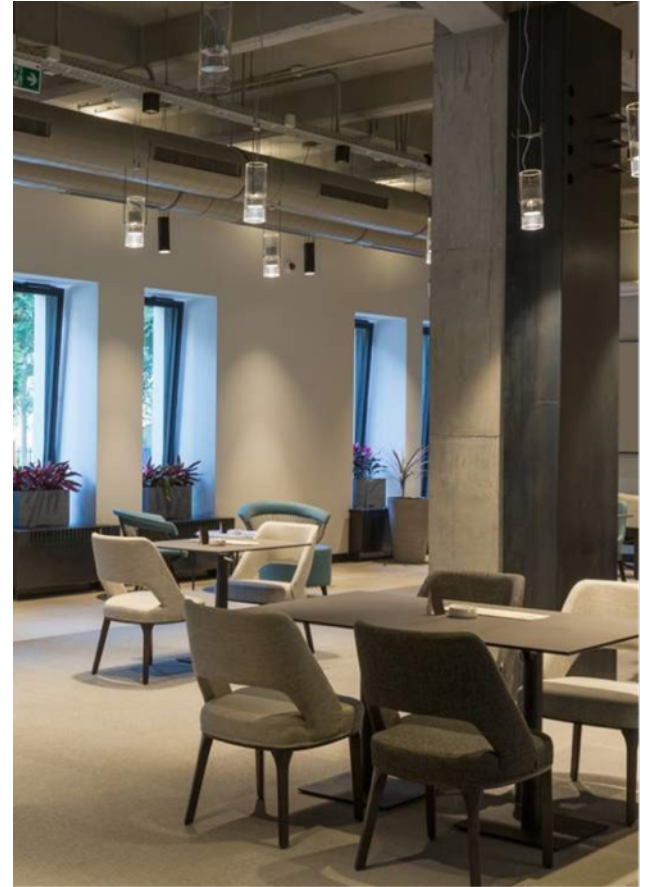

# Amenities

## Outdoor Furniture



# 5

## Selected Projects



# 212 Stuart St.



- Client: Greystar
- GC: Consigli Construction
- Architects: Sasaki Associates
- City: Boston, MA
- 129 Kitchens & 176 Baths

# 345 Harrison



- Client: UDR
- GC: John Moriarty
- Architects: CBT
- City: Boston, MA
- 585 Kitchens & 758 Baths

# Boston Garden



- Client: Boston Properties
- GC: John Moriarty
- Architects: Solomon Cordwell Buenz
- City: Boston, MA
- 327 Kitchens & 447 Baths

# Contact Us



Navona Group LLC

**Boston**

526 Tremont St  
MA 02116

**Miami**

290 NE 59th St  
FL 33137

+1 978-357-7137 | [info@thenavonagroup.com](mailto:info@thenavonagroup.com)



NAVONA

# Product Overview

6

# Product Overview



# Cabinet Structure

① Side Panel  
Fianco

② Top Panel  
Cielo

③ Shelf  
Ripiano

④ Bottom Panel  
Fondo

⑤ Back Panel  
Schiena

⑥ Door  
Anta

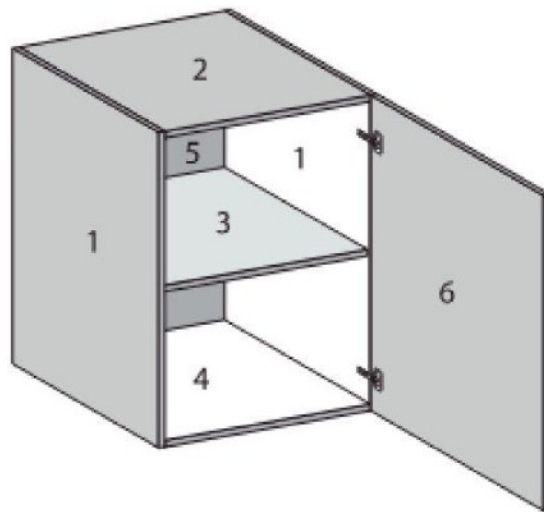
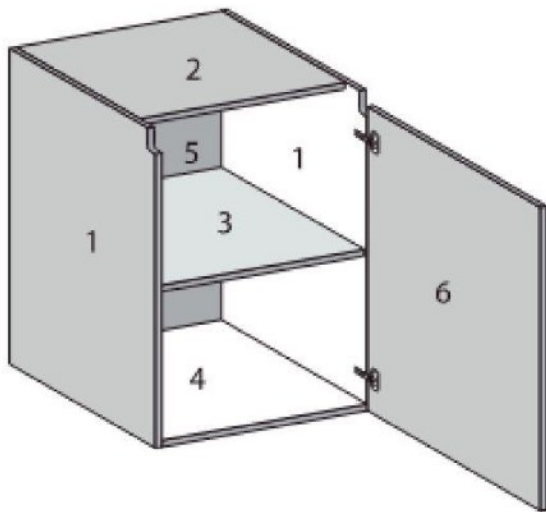

# Base Cabinet

- 3/4" MFC panels with 3mm back panel
- TSCA Title VI & CARB P2 complain
- VOC and Formaldehyde free
- Frontally-edged in ABS
- Exposed side panels that match door finishes
- Standard with adjustable, hidden brackets in depth and height
- Cabinets are affixed to wall by a metal rail system, allowing for efficient and simple installation



# Base Cabinet Accessories



- Thermoplastic, quick-clutch feet come standard with base and wall units
- Feet can be adjusted to achieve precise unit alignment

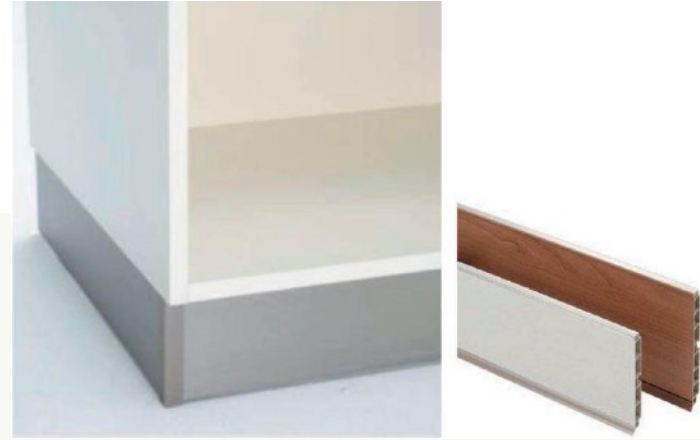

- Plinths are produced with thermoplastic, auto-extinguishing material
- Plinths available in melamine, matte oxidized aluminum veneer and solid stainless-steel
- A rubber gasket seal on the bottom side of the toe kick allows for adhesion to the floor

# Upper Cabinets

- 3/4" MFC panels with 3mm back panel
- TSCA Title VI & CARB P2 complaint
- Low formaldehyde & VOC emissions
- Frontally-edged in ABS
- Exposed side panels matching door finishes
- Standard with adjustable, hidden brackets in depth and height
- The cabinets are affixed to a metal rail bar allowing for efficient and simple installation

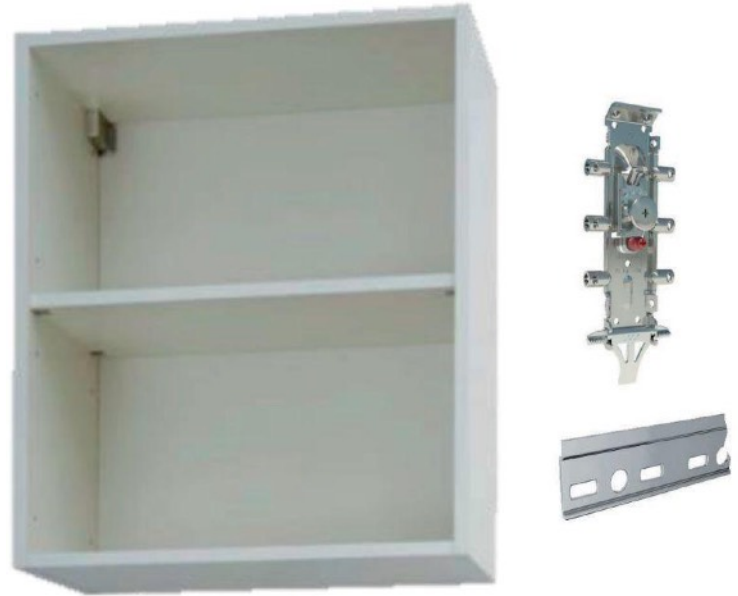

# Opening Systems

Standard Handle

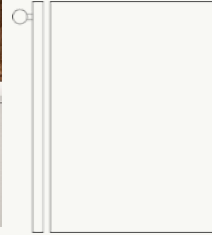

"J" Pull

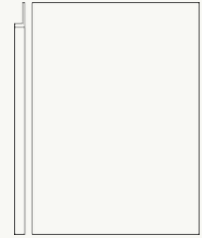

Push-Pull



Standard Handle | Flat Edge Door

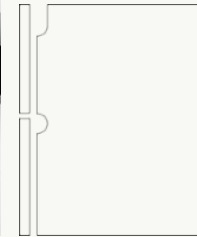

Flat Groove | 45 Edge Door

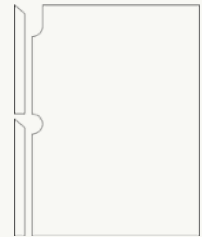

# Hinges



**Blum Clip Top**  
107° Opening, 3D Adjustment



**Blum Clip Top Blumotion**  
Integrated Blumotion



**EGV 110 Slow-Motion**  
110° Opening, Integrated Blumotion



**External Blumotion**  
107° opening, 3D adjustment



**Linear Plate**



**Cross Plate**

# Drawers



## Blum Tandembox Plus

- Full extension
- Soft close
- White or gray



## Blum Intivo

- Full extension
- Soft close
- White, gray, black or stainless-steel



## Blum Legrabox

- Full extension
- Soft close
- White, light gray, orion gray, black, havana brown or stainless-steel

# Basket Drawers



## Blum Tandembox Plus

- Full extension
- Soft close
- White or gray



## Blum Intivo Rail

- Full extension
- Soft close
- White or gray



## Blum Intivo Glass

- Full extension
- Soft close
- White or gray



## Blum Legrabox

- Full extension
- Soft close
- White, light gray, orion gray, black, havana brown or stainless-steel

# Hardware



**Wall Bracket with  
Decorative Cover**



**Maco Shelf Support**



**Hinge Arm Cover**



**Hinge Arm Cover**



**Fixed Plastic Door  
Bumper**



**Adhesive Door Bumper**

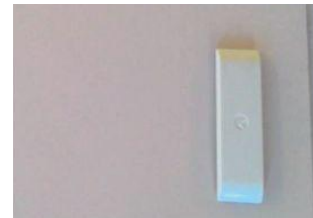

**Wall Bracket**

# Thrash Bins & Rotating System



## Magic Corner

- Chrome rotating system for 36" x 36" corner base cabinet



## Recycling Bin

- 32 Liter bin for 15" and 18" base cabinets



## Recycling Bin

- 30 Liter bin for 12" base cabinets

# LED Integrated Lighting

- LED lighting fixtures integrated on the bottom, top or side of cabinet panels
- Available in the following color temperatures: 2700K, 3000K, 4200K & 5500K
- LED Driver 75W: 110V - 12V out (dimmable option available)

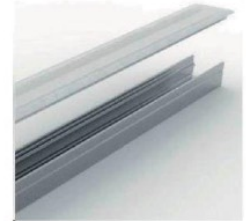

# Accessories



## Sink Liner Mat

- Protects base sink cabinet from water and chemical/detergent corrosion



## Drawer Organizers

- Selection of organizers for drawers and pull-out shelves in varying component widths



## Standard Handles

- Large selection door handles model in standard price range

# Certifications



- Certified, high-quality material sourcing
- Sustainable manufacturing process
- Certified sustainable products and finishes

- Responsible forested wood materials
- Formaldehyde free cabinetry
- VOC-free painted surfaces

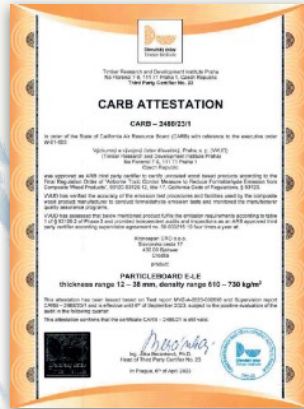

Lacey Act Form

Form No. 4-2009

Business Name: [Redacted]

Address: [Redacted]

City/State/Zip: [Redacted]

Country: [Redacted]

Product Description: [Redacted]

Harvesting Area: [Redacted]

Country of Origin: [Redacted]

Harvesting Date: [Redacted]

Harvesting Method: [Redacted]

Harvesting System: [Redacted]

Harvesting System Description: [Redacted]

Product Name	Species/Description	Volume (m³)	Value (USD)	% of Total Volume	% of Total Value
Particleboard E-E	Particleboard E-E	100	10000	100	100

Harvesting System Description: [Redacted]

Harvesting System: [Redacted]

Harvesting Method: [Redacted]

Harvesting Area: [Redacted]

Country of Origin: [Redacted]

Harvesting Date: [Redacted]

Harvesting System Description: [Redacted]

Harvesting System: [Redacted]

Harvesting Method: [Redacted]

Harvesting Area: [Redacted]

Country of Origin: [Redacted]

Harvesting Date: [Redacted]

Harvesting System Description: [Redacted]

Harvesting System: [Redacted]

Harvesting Method: [Redacted]

Harvesting Area: [Redacted]

Country of Origin: [Redacted]

Harvesting Date: [Redacted]

Harvesting System Description: [Redacted]

Harvesting System: [Redacted]

Harvesting Method: [Redacted]

Harvesting Area: [Redacted]

Country of Origin: [Redacted]

Harvesting Date: [Redacted]

Archive

# Contact Us

## Navona Group LLC

### Boston

526 Tremont St  
MA 02116

### Miami

290 NE 59th St  
FL 33137

+1 978-310-0660 | [info@thenavonagroup.com](mailto:info@thenavonagroup.com)

